

Plan PB-6-1V _ Ind2 : Huisserie métal - Pose en tableau

Gamme Porte de Communication

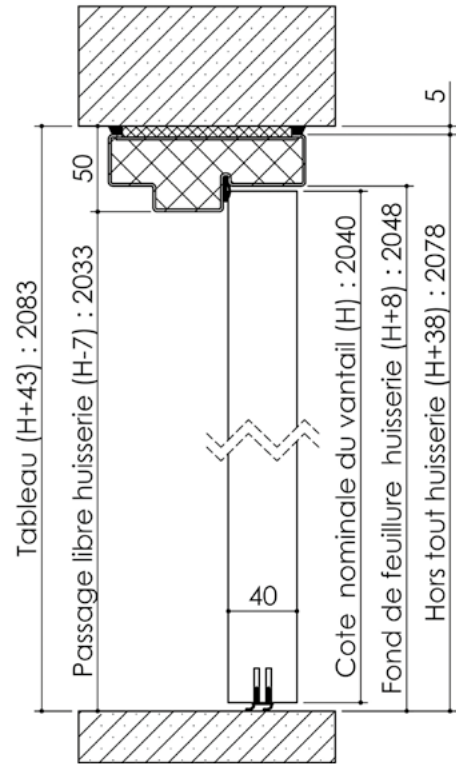
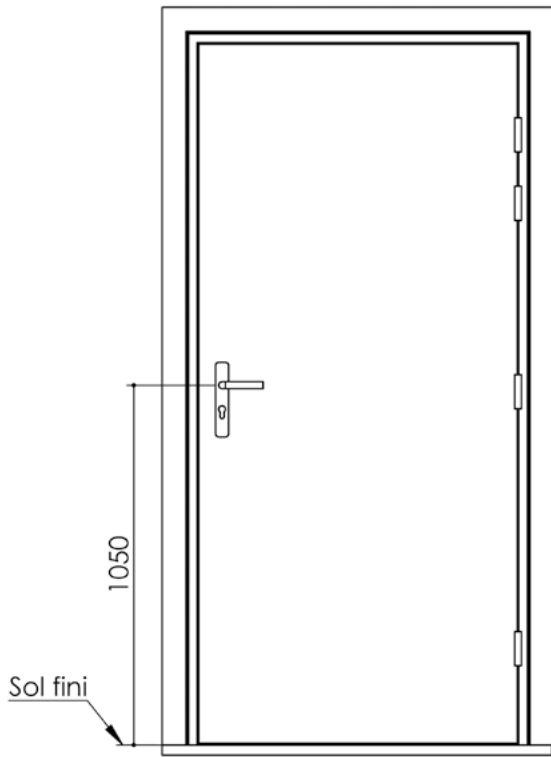

Huisserie non isophonique

Huisserie isophonique

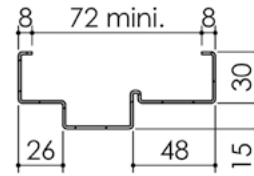
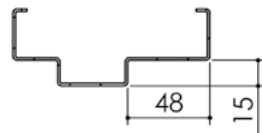

Variantes bas de porte

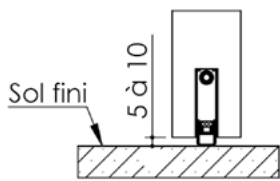

Plinthe automatique

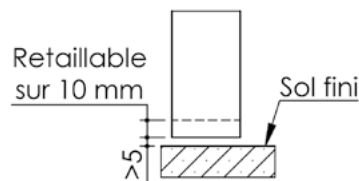

Sans joint balai

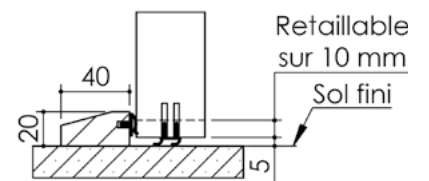

Seuil à la suisse + joint balai

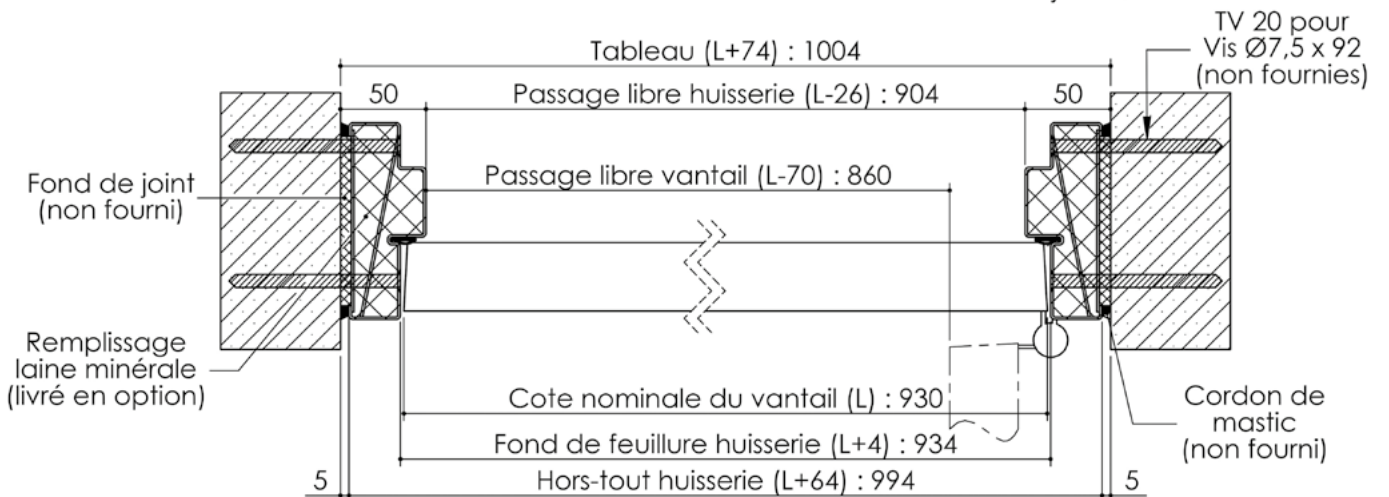

Cahier technique