

OMEGA-VEGA

Gamme Aluminium

COULISSANT

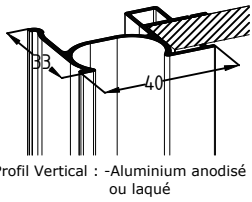
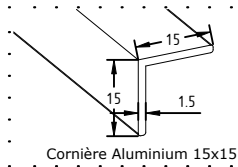

Options modèle Sillage:

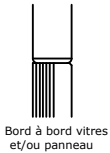

- Miroir ou Vitre laquée:
- Épaisseur : 4mm sécurisée par un film antibris montée sur un panneau épaisseur 12mm

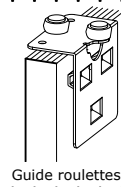
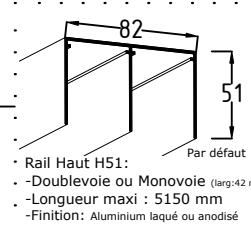
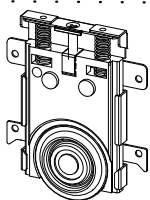

- Panneaux: -Mélaminé 2 faces E1
- Épaisseur 16 mm
- Euroclasse d-s2,d0

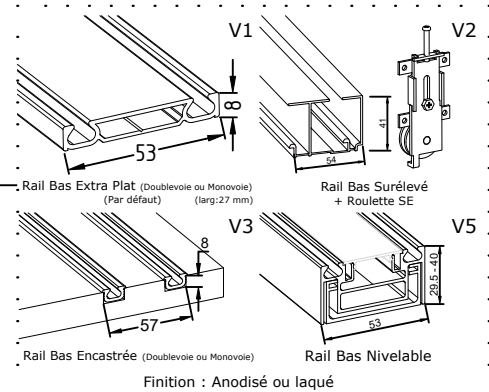
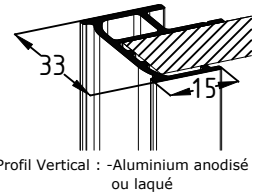

DESCRIPTIF TECHNIQUE PORTES SUR MESURE

REPLISSAGE

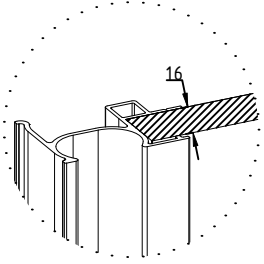

Panneau : épaisseur 16mm

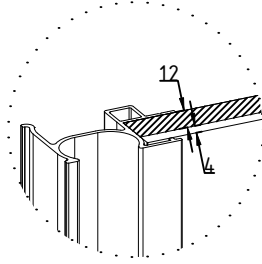

Vitre/Miroir : épaisseur 4 mm
Panneau : épaisseur 12 mm

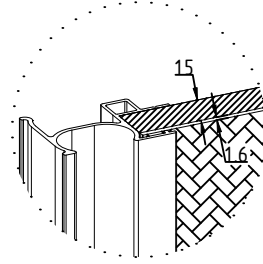

Leguan : épaisseur 1.6 mm
Panneau : épaisseur 15 mm
Hauteur Total maxi : 2600 mm

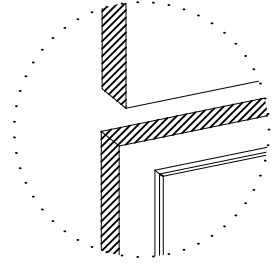

Sillage: Multiples combinaisons
suivant tableau option sillage
(au recto de la fiche)

DONNÉES TECHNIQUES

Versions rails haut/bas possible:

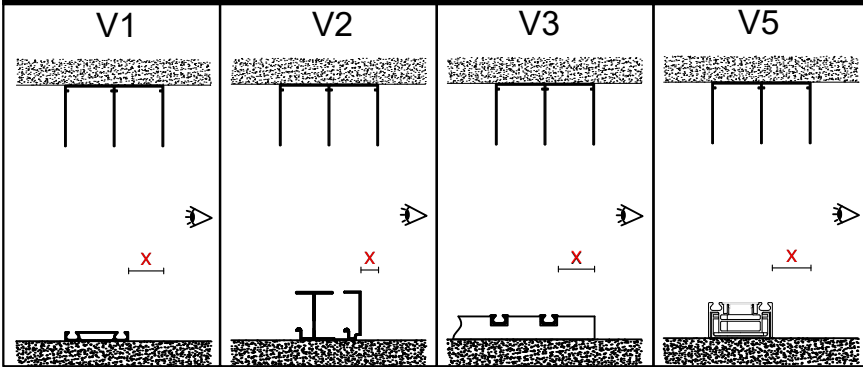

	X=Retrait rail bas/rail haut en mm
V1	26
V2	6
V3	24
V5	26

En mm	Largeur Vantail		Hauteur de Niche Hors-tout				
	Largeur Mini	Largeur Maxi	Hauteur Mini	Hauteur Maxi			
				V1	V2	V3	V5
Panneau - Miroir - Vitre Laquée ou Contrast	350	1100	350	2790	2820	2780	2810
Vitre laquée incisée				2600	2630	2590	2620
Vitre Contrast incisée				2560	2590	2550	2580
Vitre Collection Exclusive				Voir Tarif			
Sillage				2790			
Leguan	950	2600					

Vue en coupe

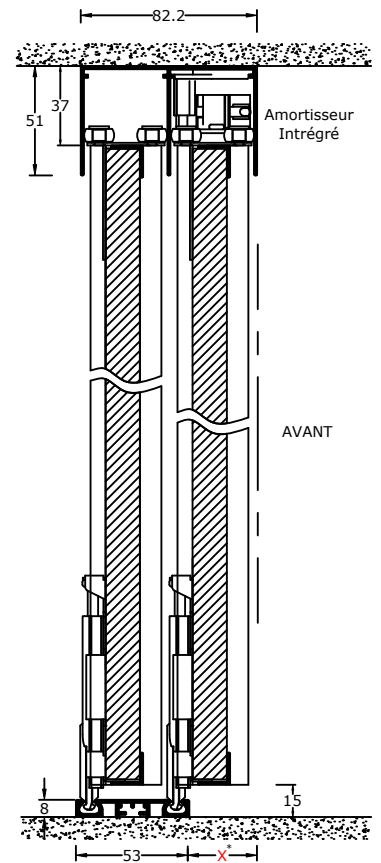

*Dépend de la version de rails choisi

Frein Amortisseur Double Intégré

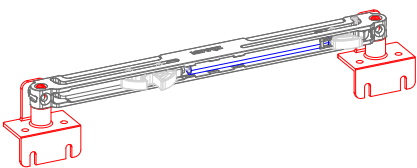

Voir Fiche Technique: AF17

Option: Coulissoft

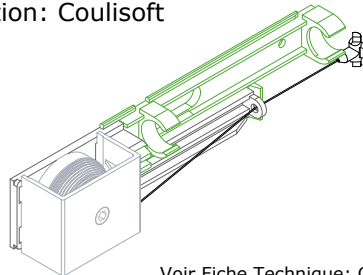

Voir Fiche Technique: CS01

